

helaform®

SERIES 100–500



STAINLESS STEEL AND ACID PROOF SERIES

100
500
kg

metal





Products for corrosive environments

Sometimes top quality carbon steel materials are not sufficient, which is why Helaform also offer you a complete range of stainless steel sliding solutions. Manufactured in both AISI 304 and AISI 316 grades they offer both corrosion resistance and acid proof solutions for weights from 100 kg up to 500 kg.

Acid proof and stainless steel products suit the most demanding sliding applications, be it in marine environments, petrochemical plants, the food industry, pharmaceutical industries or hospital and healthcare centers. We have a solution for any project you may have that demands special anti-corrosive or sterile installations.

Our stainless steel systems have also been designed for easy assembly with specially designed hangers. Helaform tracks and hangers are completely maintenance free and will last a lifetime.

Lifelong systems

Extreme or special environmental conditions are of no consequence when you specify Helaform's stainless steel products for your projects. All our series with stainless steel products are manufactured and tested to EN 1527 specifications, guaranteeing a long and trouble-free working life.

Unique solutions

Apart from the wide range of components available from stock we can also offer tailor made solutions for your special projects, thanks to our in-house design and manufacturing capabilities.

” Applications for the most demanding conditions

In addition to sliding door systems the products can also be used in a variety of other sliding applications for curtains and conveyor systems amongst others.

Highlights

- » High corrosion resistant materials; AISI 304/ 316
- » Stainless steel products up to 500 kg
- » Large variety of available products within four different series
- » 300/500 series accessories are suitable for use in both sizes of track



Stainless steel Datasheet

Specifications

	100 Series	150 Series	300 Series	500 Series
Weight (max.)	120 kg	200 kg	300 kg	500 kg
Product material	AISI 316	AISI 304	AISI 304	AISI 304
Normative (EN)	1.4404	1.4301	1.4301	1.4301



Hangers with AISI 304 / 316 steel wheels.
Lubricated for life ball bearings.



Other items AISI 304 / 316.



Example installation

100
Series

150
Series

300/500
Series

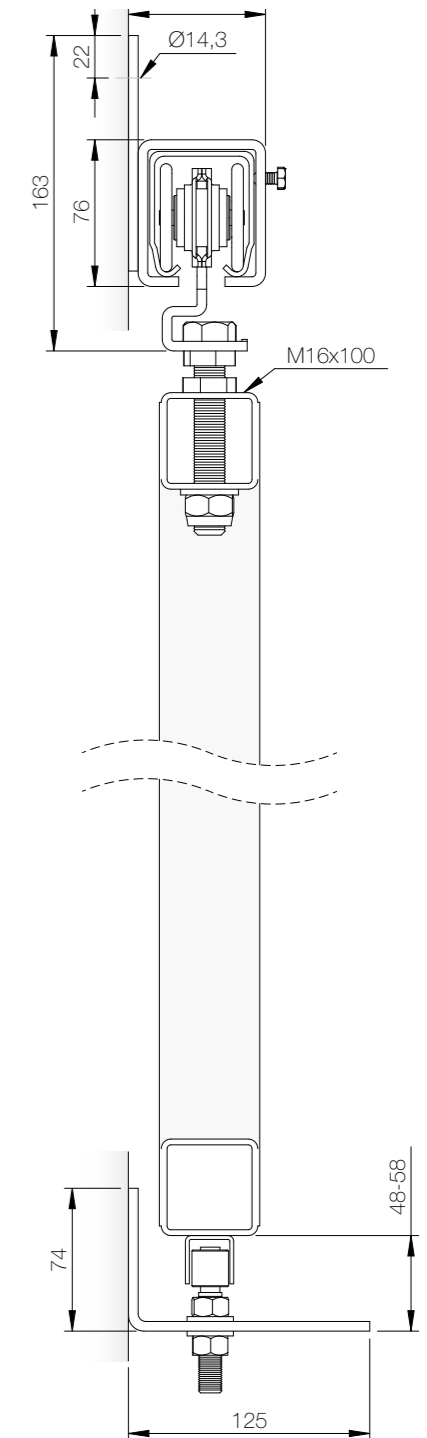
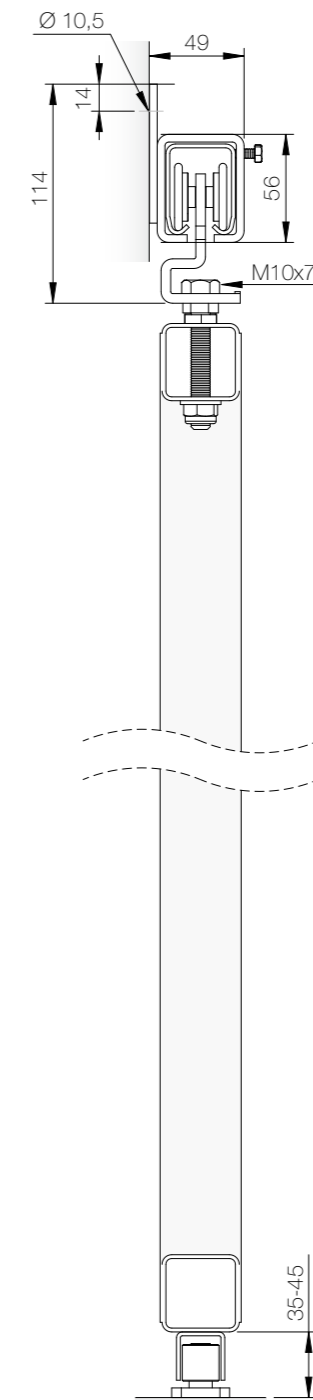
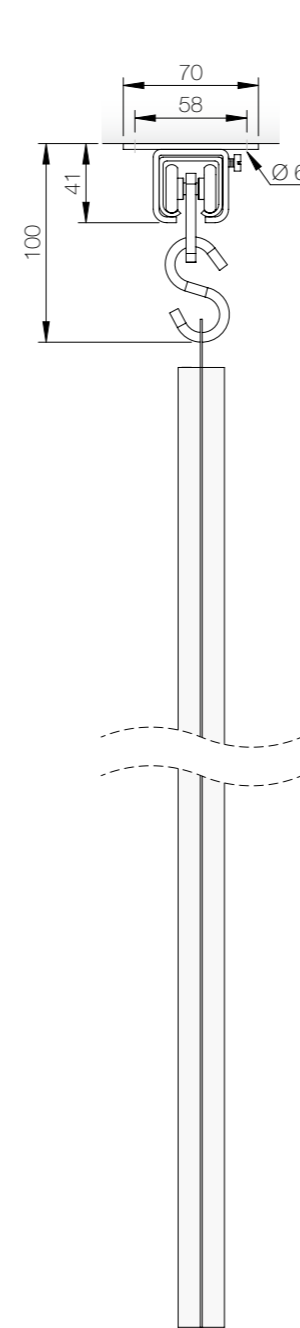















Specifying the hardware

- » Hangers are installed 2 pcs / door
- » Track length is normally twice the width of the door opening
- » Number of brackets = length of track (m) + 1 pcs
- » It's necessary to install jointing brackets at all track joints
- » Bottom guides must be used with door installations

Products and codes

100 Series – AISI 316

Track			Code
	K-100	3 m	30111
		6 m	30112
	K-100 90°	Curve 90° R=600	30113
Hangers			
	MPS-100 (Capacity 120 kg / pair)	For metal door, steel wheels	30114
	VP/2-100 (Capacity 30 kg / pc)	For curtains, steel wheels	30123
	VP/4-100 (Capacity 50 kg / pc)	For curtains, steel wheels	30134
Wall brackets			
	SKL-100	Joint bracket	30116
	SKL-100, adjustable	Adjustable joint bracket	30118
	SKL/2-100	Double joint bracket	30117
Soffit brackets			
	KKL-100	Joint bracket	30119
	KKL/2-100	Double joint bracket	30120
Accessories			
	LKU-100/100 mm	Joint	30121
	KPP-075/100	Track stop	30122
	KP-100/150	Track stop	40112
	S-50/5.5	S-hook	30124



150 Series – AISI 304

Track			
	K-150	2 m	40022
		3 m	40023
		4 m	40024
		6 m	40026
Hangers			
	MPS-150 (Capacity 200 kg / pair)	Hanger for metal door, steel wheels	40050
	VP/2-150 (Capacity 50 kg / pc)	Hanger for curtain, steel wheels	40063
	VP/4-150 (Capacity 100 kg / pc)	Hanger for curtain, steel wheels	40064



Wall brackets

	SK-151	Bracket	40076
	SKL-151	Joint bracket	40077

Soffit brackets

			Code
	KK-151	Bracket	40091
	KKL-151	Joint bracket	40092
	KKK-151	Bracket	40093
	KKKL-151	Joint bracket	40094

Accessories

	LKU-150/100 mm	Joint	40095
	100/150 M10 x 140	Plate for timber door, top fixing	40102
	KP-100/150	Track stop	40112

300/500 Series – AISI 304

Track			
	K-300 (Capacity 300 kg) K-500 (Capacity 500 kg)	6 m	50021
		4 m	50029
		6 m	50030
Hangers			
	MPS-300/500 (Capacity 500 kg/pair)	Hanger for metal doors, steel wheels	50053
Wall brackets			
	SK-301/501	Bracket	50078
	SKL-301/501	Joint bracket	50079
Soffit brackets			
	KK-301/501	Bracket	50094
	KKL-301/501	Joint bracket	50095
	KKK-301/501	Bracket	50096
	KKKL-301/501	Joint bracket	50097
	KK-301/501/M12 x 120	Bracket, with bolt	50093
Accessories			
	300/500 M16 x 180	Plate for timber door, top fixing	50105
	KP-300/500	Track stop	50112

Bottom guides and channel (all series)

	AOK	Bottom guide track 3 m AISI 316	50310
	AO-12 Ø 19 mm	Bottom guide, wall fixed AISI 304	50325
	AOL-12 Ø 19 mm	Bottom guide, floor fixed AISI 316	50339

- » Jointing brackets include screws for tightening the bracket to the track. Jointing brackets can also be used for track joints.
- » 3D models, DWG and PDF drawings of the specific items can be found on our web page.

Reference



Protective curtains on oil rigs in the North Sea are installed with Helaform stainless steel products.

Company information

Helaform is a Finnish, family owned company manufacturing sliding and folding door systems with capacities up to 2000 kg. With over 30 years of experience Helaform is one of the world's leading suppliers of sliding and folding door systems.

Helaform product range covers everything from modern architectural and industrial applications to ecological enhancements, such as greenhouse plant watering systems.

